

# Pulse PRO



## Caractéristiques

### Clavier

- 10 Boutons poussoir alphanumériques
- Essais boutons poussoir
- DST automatique
- LED rouge
- Bip sonore
- Compartiment à pile
- Lecteur de clés Dallas
- Clavier fixe / rotatif
- Contrôle du niveau de pile
- Fonction de désactivation du bip
- Compatible avec les serrures numériques
- Compatible avec les serrures analogiques
- 12 Boutons de fonction
- Alimentation:
  - Pile alcaline 9V
  - Grand boîtier de pile
  - Alimentation directe

### Serrures

- 2 Codes maître
- 3 Codes manager
- 49 Codes utilisateurs
- 10 Codes courrier
- Temporisation 1-99 minutes
- Fenêtre ouverte 1-19 minutes
- Alarme silencieuse
- Désactivation de l'ouverture à distance
- Suppression de la temporisation à distance
- Alarme sur porte ouverte
- Pénalité
- Sortie de l'état du pêne
- Clés Dallas
- Mode double code (4 yeux)
- Audit avec heure et date (jusqu'à 5500 événements)
- Configurations préprogrammées (plus de 80)
- Entièrement configurable par clavier
- Mode hôtel
- Réinitialisation
- ERC - Code de réinitialisation

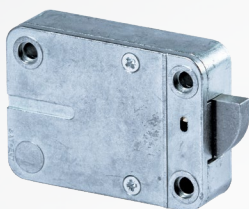

RotoBolt

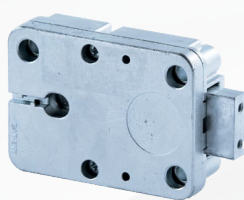

StraightBolt

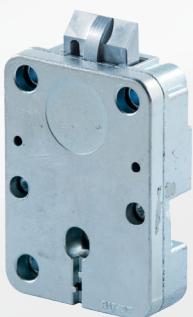

SpringBolt



MotorLock



Motor SpringBolt

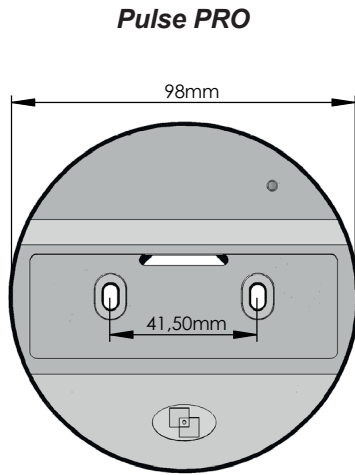

### RotoBolt

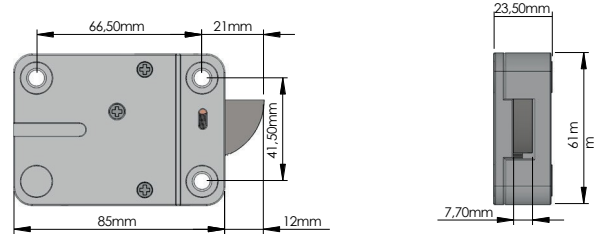

### StraightBolt

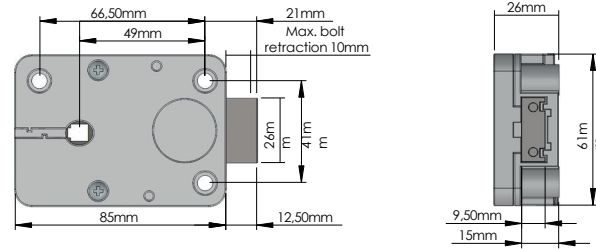

### SpringBolt

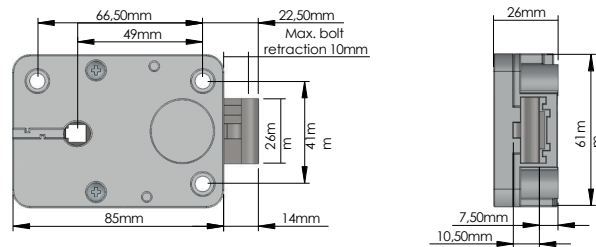

### MotorLock

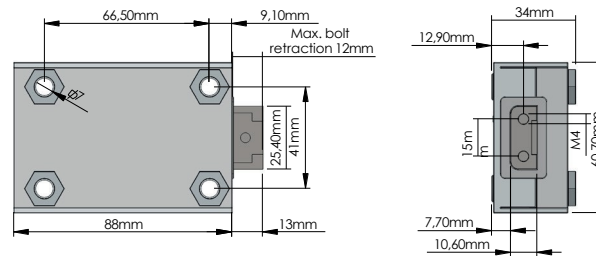

### Motor SpringBolt

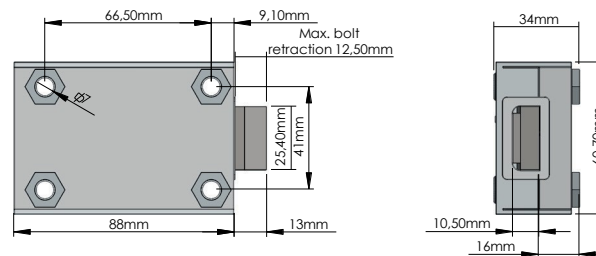

#### GLOBAL HEADQUARTERS

Tecnosicurezza  
Via C. Battisti, 276  
37057 S.Giovanni Lup.(VR)  
ITALY  
[info@tecnosicurezza.it](mailto:info@tecnosicurezza.it)  
[www.tecnosicurezza.it](http://www.tecnosicurezza.it)

#### USA HEADQUARTERS

Tecnosicurezza  
50, Thomas Lane  
Versailles, KY 40383  
USA  
[info@usatecno.com](mailto:info@usatecno.com)  
[www.usatecno.com](http://www.usatecno.com)

#### SPAIN HEADQUARTERS

Tecnosicurezza  
C/Menor, 4 - Nave 10, Pol Ind. "La Mina"  
28770 Colmenar Viejo  
SPAIN  
[info@tecnosicurezza.es](mailto:info@tecnosicurezza.es)  
[www.tecnosicurezza.es](http://www.tecnosicurezza.es)